

Network Video Recorder

Quick Operation Guide

TABLE OF CONTENTS

| | |
|--|-----------|
| NVR Pre-Installation | 2 |
| NVR Installation | 2 |
| Hard Disk Installation | 2 |
| Front Panel | 5 |
| Rear Panel | 10 |
| Peripheral Connections | 12 |
| Wiring of Alarm Input..... | 12 |
| Wiring of Alarm Output | 12 |
| Using of Alarm Connectors..... | 12 |
| Controller Connection..... | 13 |
| Specifications | 14 |
| Specifications of HNRT00 Series | 14 |
| Specification of HNR50P6 Series | 15 |
| HDD Storage Calculation Chart | 17 |
| Accessing by Web Browser | 18 |
| Logging In..... | 18 |
| Live View..... | 18 |
| Recording..... | 19 |
| Playback..... | 21 |
| Log 22 | |
| Menu Operation | 23 |
| Menu Structure..... | 23 |
| Startup and Shutdown | 23 |
| Live View | 24 |
| Adding IP Cameras | 24 |
| One-touch RAID Configuration | 26 |
| Recording | 27 |
| Instant Recording | 27 |
| All-day Recording | 28 |
| Playback..... | 28 |
| Backup..... | 29 |

Thank you for purchasing our product. If there is any question or request, please do not hesitate to contact dealer. This manual is applicable to the models listed in the following table.

| Series | Model | Type |
|---------|--------------------------|------------------------|
| HNRT00 | HNRT00-32 HNRT00-64 | Network Video Recorder |
| HNR50P6 | HNR50P6-16 HNR50P6-32 | Network Video Recorder |
| | | |

NVR Pre-Installation

The HNRT00 and HNR50P6 series NVR are highly advanced surveillance equipment that should be installed with care. Please take into consideration the following precautionary steps before installation of the NVR.

1. Keep all liquids away from the NVR.
2. Install the NVR in a well-ventilated and dust-free area.
3. Ensure environmental conditions meet factory specifications.
4. Install a manufacturer recommended HDD.

NVR Installation

During the installation of the NVR:

1. Use brackets for rack mounting.
2. Ensure there is ample room for audio and video cables.
3. When routing cables, ensure that the bend radius of the cables are no less than five times than its diameter.
4. Connect both the alarm and RS-485 cable.
5. Allow at least 2cm (~0.75-inch) of space between racks mounted devices.
6. Ensure the NVR is grounded.
7. Environmental temperature should be within the range of -10 °C ~ 55 °C, 14°F ~ 131°F.
8. Environmental humidity should be within the range of 10% ~ 90%.

Hard Disk Installation

Before you start:

Disconnect the power from the NVR before installing a hard disk drive (HDD). A factory recommended HDD should be used for this installation.

Up to 8 SATA hard disks can be installed on your NVR.

Tools Required: Screwdriver.

Steps (for HNRT00 Series):

1. Fasten the hard disk mounting handle to the hard disk with screws.



2. Insert the key and turn in clockwise direction to open the panel lock.



3. Press the buttons on the panel of two sides and open the front panel.



4. Insert the hard disk along the slot until it is placed into position.

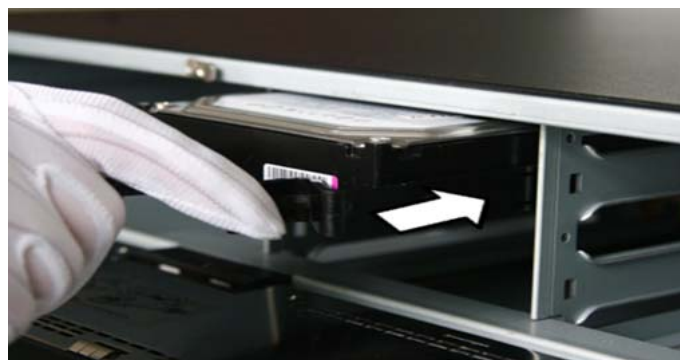

5. Repeat the above steps to install other hard disks onto the NVR. After having finished the installation of all hard disks, close the front panel and lock it with the key again.



Steps (for HNR50P6 Series):

1. Remove the cover from the NVR by unfastening the screws on the rear and side panel.

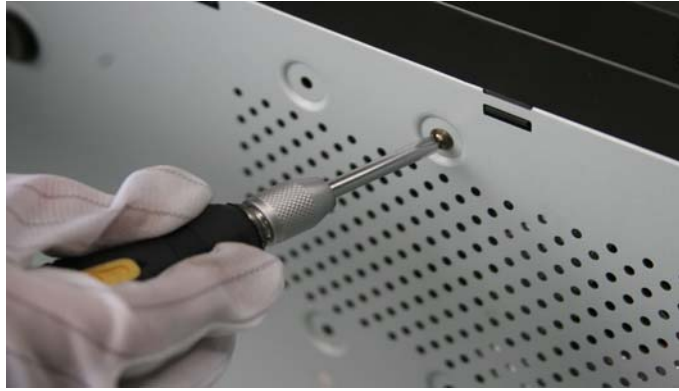

2. Connect one end of the data cable to the motherboard of NVR and the other end to the HDD.

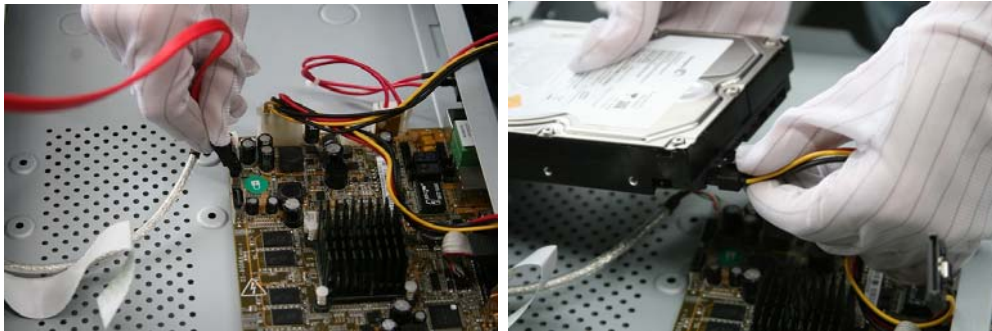

3. Connect the power cable to the HDD.



4. Place the HDD on the bottom of the device and then fasten the screws on the bottom to fix the HDD.



Front Panel

HNRT00 Series

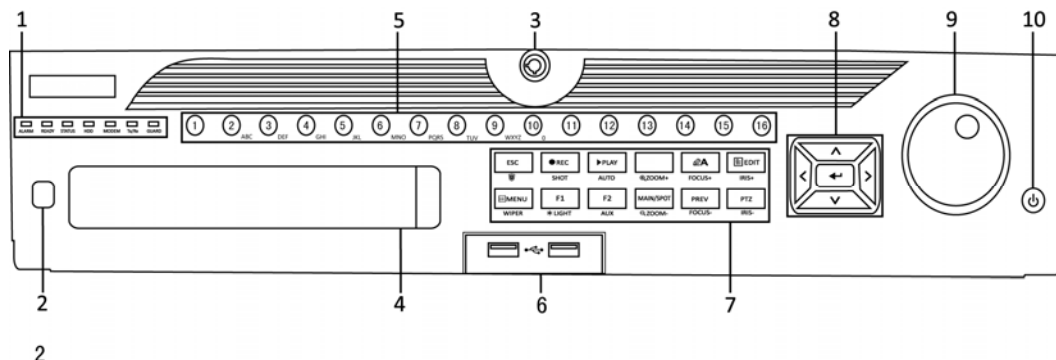

| No. | Name | Function Description | |
|--------------|---|---|--|
| 1 | Status Indicators | ALARM | Turns red when a sensor alarm is detected. |
| | | READY | Ready LED is normally blue, indicating that the device is functioning properly. |
| | | STATUS | Turns blue when device is controlled by an IR remote. |
| | | | Turns red when controlled by a keyboard and purple when IR remote and keyboard is used at the same time. |
| | | HDD | Flashes red when data is being read from or written to HDD. |
| | | MODEM (not for HNRT00) | Reserved for future usage. |
| | | TX/RX | Flashes blue when network connection is functioning properly. |
| GUARD | Guard LED turns blue when the device is in armed status; at this time, an alarm is enabled when an event is detected. | | |
| | The LED turns off when the device is unarmed. The arm/disarm status can be changed by pressing and holding on the ESC button for more than 3 seconds in live view mode. | | |
| 2 | IR Receiver | Receiver for IR remote | |
| 3 | Front Panel Lock (for HNRT00 series) | You can lock or unlock the panel by the key. | |
| 4 | DVD-R/W | Slot for DVD-R/W. | |
| 5 | Alphanumeric Buttons | Switch to the corresponding channel in Live view or PTZ Control mode. | |
| | | Input numbers and characters in Edit mode. | |
| | | Switch between different channels in Playback mode. | |
| | | The light of the button is blue when the corresponding channel is recording; it is red when the channel is in network transmission status; it is pink when the channel is recording and transmitting. | |
| 6 | USB Interfaces | Universal Serial Bus (USB) ports for additional devices such as USB mouse and USB Hard Disk Drive (HDD). | |
| 7 | Composite Keys | ESC | Back to the previous menu. |
| | | | Press for Arming/disarming the device in Live View mode. |

| No. | Name | Function Description |
|-----|------------------------|--|
| | REC/SHOT | Enter the Manual Record setting menu. |
| | | In PTZ control settings, press the button and then you can call a PTZ preset by pressing Numeric button. |
| | | It is also used to turn audio on/off in the Playback mode. |
| | PLAY/AUTO | The button is used to enter the Playback mode. |
| | | It is also used to auto scan in the PTZ Control menu. |
| | ZOOM+ | Zoom in the PTZ camera in the PTZ Control setting. |
| | A/FOCUS+ | Adjust focus in the PTZ Control menu. |
| | | It is also used to switch between input methods (upper and lowercase alphabet, symbols and numeric input). |
| | EDIT/IRIS+ | Edit text fields. When editing text fields, it will also function as a Backspace button to delete the character in front of the cursor. |
| | | On checkbox fields, pressing the button will <i>tick</i> the checkbox. |
| | | In PTZ Control mode, the button adjusts the iris of the camera. In Playback mode, it can be used to generate video clips for backup. |
| | | Enter/exit the folder of USB device and eSATA HDD. |
| | MAIN/SPOT/ZOOM- | Switch between main and spot output. |
| | | In PTZ Control mode, it can be used to zoom out the image. |
| | F1/ LIGHT | Select all items on the list when used in a list field. |
| | | In PTZ Control mode, it will turn on/off PTZ light (if applicable). |
| | | In Playback mode, it is used to switch between play and reverse play. |
| | F2/ AUX | Cycle through tab pages. |
| | | In synchronous playback mode, it is used to switch between channels. |
| | MENU/WIPER | Press the button will help you return to the Main menu (after successful login). |
| | | Press and hold the button for 5 seconds will turn off audible key beep. |
| | | In PTZ Control mode, the MENU/WIPER button will start wiper (if applicable). |
| | | In Playback mode, it is used to show/hide the control interface. |
| | PREV/FOCUS- | Switch between single screen and multi-screen mode. |
| | | In PTZ Control mode, it is used to adjust the focus in conjunction with the A/FOCUS+ button. |
| | PTZ/IRIS- | Enter the PTZ Control mode. |
| | | In the PTZ Control mode, it is used to adjust the iris of the PTZ camera. |
| 8 | Control Buttons | <p>DIRECTION</p> <p>The DIRECTION buttons are used to navigate between different fields and items in menus.</p> <p>In the Playback mode, the Up and Down button is used to speed up and slow down recorded video. The Left and Right button will select the next and previous record files.</p> |

| No. | Name | Function Description |
|-----|----------------------------|---|
| | ENTER | In Live View mode, these buttons can be used to cycle through channels. |
| | | In PTZ control mode, it can control the movement of the PTZ camera. |
| | | The ENTER button is used to confirm selection in any of the menu modes. |
| | | It can also be used to <i>tick</i> checkbox fields. |
| | | In Playback mode, it can be used to play or pause the video. |
| | | In single-frame Playback mode, pressing the button will advance the video by a single frame. |
| | | In Auto-switch mode, it can be used to stop /start auto switch. |
| 9 | JOG SHUTTLE Control | Move the active selection in a menu. It will move the selection up and down. |
| | | In Live View mode, it can be used to cycle through different channels. |
| | | In the Playback mode: For HNR00 series, the ring is used to jump 30s forward/backward in video files. |
| | | In PTZ control mode, it can control the movement of the PTZ camera. |
| 10 | POWER ON/OFF | Power on/off switch. |

HNR50P6 Series

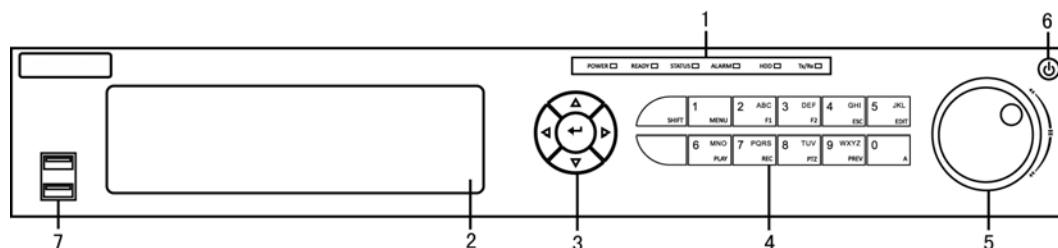

| No. | Name | Function Description | |
|-----|--------------------------|----------------------|--|
| 1 | Status Indicators | POWER | Turns green when NVR is powered up. |
| | | READY | The LED is green when the device is running normally. |
| | | STATUS | The light is green when the IR remote control is enabled; The light is red when the function of the composite keys (SHIFT) are used; The light is out when none of the above condition is met. |
| | | ALARM | The light is red when there is an alarm occurring. |
| | | HDD | Blinks red when HDD is reading/writing. |
| | | Tx/Rx | Blinks green when network connection is functioning normally. |

| No. | Name | Function Description | |
|-----|-----------------|----------------------|---|
| 2 | DVD-R/W | Slot for DVD-R/W. | |
| 3 | Control Buttons | DIRECTION | In menu mode, the direction buttons are used to navigate between different fields and items and select setting parameters. |
| | | | In playback mode, the Up and Down buttons are used to speed up and slow down record playing, and the Left and Right buttons are used to move the recording 30s forwards or backwards. |
| | | | In the image setting interface, the up and down button can adjust the level bar of the image parameters. |
| | | | In live view mode, these buttons can be used to switch channels. |
| | | ENTER | The Enter button is used to confirm selection in menu mode; or used to check checkbox fields and ON/OFF switch. |
| | | | In playback mode, it can be used to play or pause the video. |
| | | | In single-frame play mode, pressing the Enter button will play the video by a single frame. |
| | | | In auto sequence view mode, the buttons can be used to pause or resume auto sequence. |
| 4 | Composite Keys | SHIFT | Switch between the numeric or letter input and functions of the composite keys. (Input letter or numbers when the light is out; Realize functions when the light is red.) |
| | | | |
| | | 1/MENU | Enter numeral "1"; |
| | | | Access the main menu interface. |
| | | 2/ABC/F1 | Enter numeral "2"; |
| | | | Enter letters "ABC"; |
| | | | The F1 button when used in a list field will select all items in the list. |
| | | | In PTZ Control mode, it will turn on/off PTZ light and when the image is zoomed in, the key is used to zoom out. |
| | | 3/DEF/F2 | Enter numeral "3"; |
| | | | Enter letters "DEF"; |
| | | | The F2 button is used to change the tab pages. |
| | | | In PTZ control mode, it zooms in the image. |
| | | 4/GHI/ESC | Enter numeral "4"; |
| | | | Enter letters "GHI"; |
| | | | Exit and back to the previous menu. |
| | | | |
| | | 5/JKL/EDIT | Enter numeral "5"; |
| | | | Enter letters "JKL"; |
| | | | Delete characters before cursor; |
| | | | Check the checkbox and select the ON/OFF switch; |
| | | | Start/stop record clipping in playback. |
| | | 6/MNO/PLAY | Enter numeral "6"; |
| | | | Enter letters "MNO"; |
| | | | Playback, for direct access to playback interface. |
| | | 7/PQRS/REC | Enter numeral "7"; |
| | | | Enter letters "PQRS"; |
| | | | Open the manual record interface. |

| No. | Name | | Function Description |
|-----|----------------------------|--|---|
| | | 8/TUV/PTZ | Enter numeral "8"; |
| | | | Enter letters "TUV"; |
| | | | Access PTZ control interface. |
| | | 9/WXYZ/PRE V | Enter numeral "9"; |
| | | | Enter letters "WXYZ"; |
| | | | Multi-channel display in live view. |
| | | 0/A | Enter numeral "0"; |
| | | | Shift the input methods in the editing text field. (Upper and lowercase, alphabet, symbols or numeric input). |
| | | | Double press the button to switch the main and auxiliary output. |
| 5 | JOG SHUTTLE Control | Move the active selection in a menu. It will move the selection up and down. | |
| | | In Live View mode, it can be used to cycle through different channels. | |
| | | In the Playback mode, it can be used to jump 30s forward/backward in video files. | |
| | | In PTZ control mode, it can control the movement of the PTZ camera. | |
| 6 | POWER ON/OFF | Power on/off switch. | |
| 7 | USB Interfaces | Universal Serial Bus (USB) ports for additional devices such as USB mouse and USB Hard Disk Drive (HDD). | |

Rear Panel

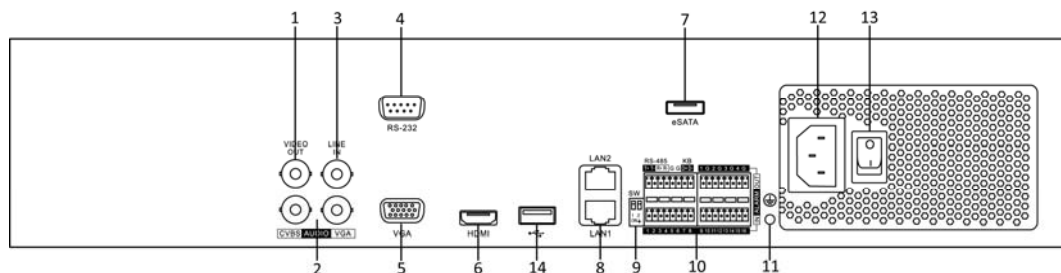

HNRT00 Series

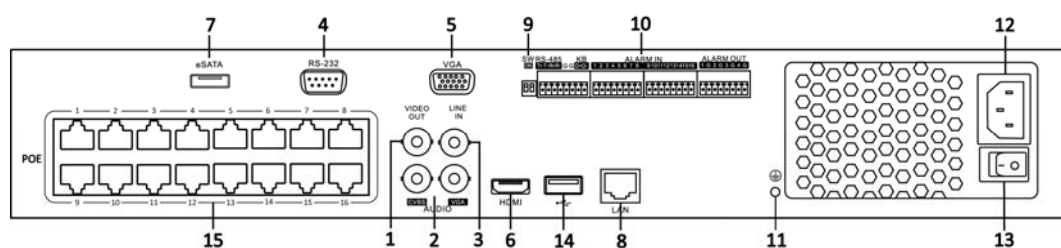

HNR50P6-32

| No. | Item | Description |
|-----|---------------------------|---|
| 1 | VIDEO OUT | BNC connector for video output. |
| 2 | CVBS AUDIO OUT | BNC connector for audio output. This connector is synchronized with CVBS video output. |
| | VGA AUDIO OUT | BNC connector for audio output. This connector is synchronized with VGA video output. |
| 3 | LINE IN | BNC connector for audio input. |
| 4 | RS-232 Interface | Connector for RS-232 devices. |
| 5 | VGA | DB9 connector for VGA output. Display local video output and menu. |
| 6 | HDMI | HDMI video output connector. |
| 7 | eSATA (Optional) | Connects external SATA HDD, CD/DVD-RM. |
| 8 | LAN Interface | 1 network interface provided for HNR50P6 series and 2 network interfaces for HNRT00 series |
| 9 | Termination Switch | RS-485 termination switch. Up position is not terminated. Down position is terminated with 120Ω resistance. |
| 10 | RS-485 Interface | Connector for RS-485 devices. T+ and T- pins connect to R+ and R- pins of PTZ receiver respectively. |
| | Controller Port | D+, D- pin connects to Ta, Tb pin of controller. For cascading devices, the first NVR's D+, D- pin should be connected with the D+, D- pin of the next NVR. |
| | ALARM IN | Connector for alarm input. |
| | ALARM OUT | Connector for alarm output. |
| 11 | GROUND | Ground(needs to be connected when NVR starts up). |

| No. | Item | Description |
|-----|--|--|
| 12 | AC 100V ~ 240V | AC 100V ~ 240V power supply. |
| 13 | POWER | Switch for turning on/off the device. |
| 14 | USB interface | Universal Serial Bus (USB) ports for additional devices such as USB mouse and USB Hard Disk Drive (HDD). |
| 15 | Network Interfaces with PoE function (supported by HNR50P6 only) | Network interfaces for the cameras and to provide power over Ethernet. |

Peripheral Connections

Wiring of Alarm Input

The alarm input is an open/closed relay. To connect the alarm input to the device, use the following diagram.



If the alarm input is not an open/close relay, please connect an external relay between the alarm input and the device.

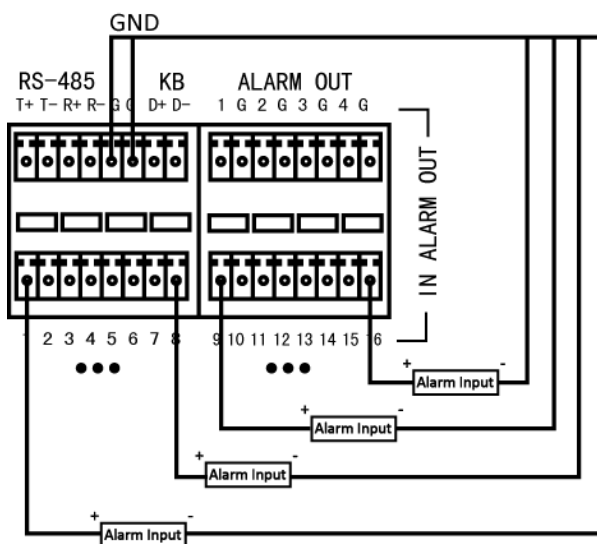

Wiring of Alarm Output

To connect to an alarm output (AC or DC load), use the following diagram:

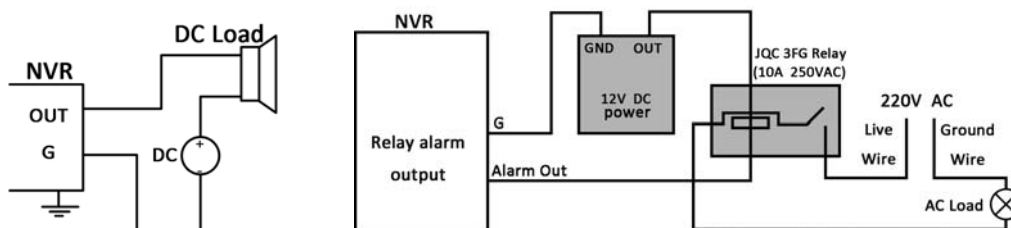

DC Load Connection Diagram

AC Load Connection Diagram

For DC load, the jumpers can be used within the limit of 12V/1A safely.

To connect an AC load, jumpers should be left open (you must remove the jumper on the motherboard in the NVR). Use an external relay for safety (as shown in the figure above).

There are 4 jumpers (JP1, JP2, JP3, and JP4) on the motherboard, each corresponding with one alarm output. By default, jumpers are connected. To connect an AC load, jumpers should be removed.

Example:

If you connect an AC load to the alarm output 3 of the NVR, then you must remove the JP 3.

Using of Alarm Connectors

To connect alarm devices to the NVR:

1. Disconnect *pluggable block* from the ALARM IN /ALARM OUT terminal block.
2. Unfasten stop screws from the *pluggable block*, insert signal cables into slots and fasten stop screws. Ensure signal cables are in tight.

3. Connect *pluggable block* back into terminal block.

Controller Connection

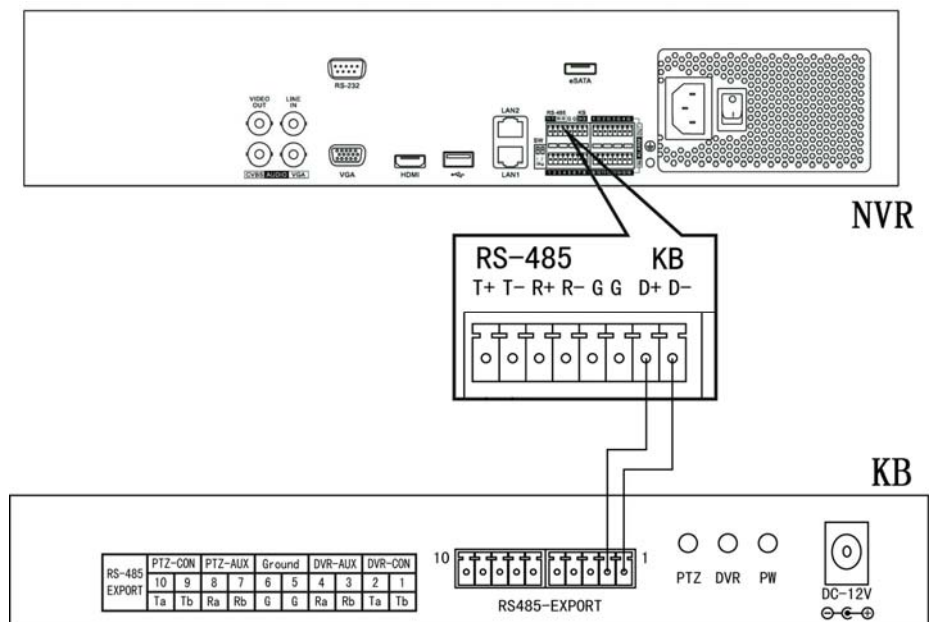

To connect a controller to the NVR:

1. Disconnect pluggable block from the KB terminal block.
2. Unfasten stop screws from the KB D+, D- *pluggable block*, insert signal cables into slots and fasten stop screws. Ensure signal cables are in tight.
3. Connect Ta on controller to D+ on terminal block and Tb on controller to D- on terminal block. Fasten stop screws.
4. Connect *pluggable block* back into terminal block.



Make sure both the controller and NVR are grounded.

Specifications

Specifications of HNRT00 Series

| Model | | N/A | N/A | HNRT00-3 2 | HNRT00-64 |
|----------------------|--|--|--------|---------------|-----------|
| Video/Audio input | IP video input | 8-ch | 16-ch | 32-ch | 64-ch |
| | Two-way audio | 1-ch, BNC (2.0 Vp-p, 1kΩ) | | | |
| Video/Audio output | Recording resolution | 5MP /3MP /1080P /UXGA /720P /VGA /4CIF /DCIF /2CIF /CIF /QCIF | | | |
| | Frame rate | Main stream: 25 fps (P) / 30 fps (N) | | | |
| | | Sub-stream: 25 fps (P) / 30 fps (N) | | | |
| | CVBS output | 1-ch, BNC (1.0 Vp-p, 75 Ω) Resolution: 704 × 576 (PAL); 704 × 480 (NTSC) | | | |
| | HDMI output | 1-ch, resolution: 1920 × 1080P /60Hz, 1920×1080P /50Hz, 1600 × 1200/60Hz, 1280 × 1024 /60Hz, 1280 × 720 /60Hz, 1024 × 768 /60Hz | | | |
| | VGA output | 1-ch, resolution: 1920 × 1080P /60Hz, 1600 × 1200 /60Hz, 1280 × 1024 /60Hz, 1280 × 720 /60Hz, 1024 × 768 /60Hz | | | |
| | Audio output | 2-ch, BNC (Linear, 600Ω) | | | |
| | Playback resolution | 5MP /3MP /1080P /UXGA /720P /VGA /4CIF /DCIF /2CIF /CIF /QCIF | | | |
| Synchronous playback | 8-ch | 16-ch | 16-ch | 16-ch | |
| Hard disk | SATA | 8 SATA interfaces for 4 HDDs + 1 DVD-R/W (default), or 8HDDs | | | |
| | eSATA | 1 eSATA interface | | | |
| | Capacity | Up to 4TB capacity for each HDD | | | |
| Disk array | Array type | RAID0, RAID1, RAID5, RAID10 | | | |
| | Number of array | 8 | | | |
| | Number of virtual disk | 8 | | | |
| External interface | Network interface | 2 RJ-45 10/100/1000 Mbps self-adaptive Ethernet interfaces | | | |
| | Serial interface | RS-232; RS-485; Keyboard | | | |
| | USB interface | 3 × USB 2.0 | | | |
| | Alarm in | 16 | | | |
| | Alarm out | 4 | | | |
| Others | Power supply | 100 ~ 240 VAC, 6.3 A, 50 ~ 60 Hz | | | |
| | Consumption (without hard disk or DVD-R/W) | ≤ 35 W | ≤ 40 W | ≤ 45 W | ≤ 45 W |
| | Working temperature | -10 °C ~ +55 °C | | | |
| | Working humidity | 10 % ~ 90 % | | | |
| | Chassis | 19-inch rack-mounted 2U chassis | | | |
| | Dimensions (W × D × H) | 445 × 470 × 90 mm (17.52" × 18.5" × 3.54") | | | |
| | Weight | ≤ 11 Kg (24.2 lb) (without hard disk or DVD-R/W) | | | |

Specification of HNR50P6 Series

| Model | | N/A | HNR50P6-16 | HNR50P6-32 |
|----------------------|--------------------------------------|--|--|------------|
| Video/Audio input | IP video input | 8-ch | 16-ch | 32-ch |
| | Two-way audio | 1-ch, BNC (2.0 Vp-p, 1k Ω) | | |
| Video/Audio output | Recording resolution | 5MP /3MP /1080P /UXGA /720P /VGA /4CIF /DCIF /2CIF /CIF /QCIF | | |
| | Frame rate | Main stream: 25 fps (P) / 30 fps (N) | | |
| | | Sub-stream: 25 fps (P) / 30 fps (N) | | |
| | CVBS output | 1-ch, BNC (1.0 Vp-p, 75 Ω) Resolution: 704 \times 576 (PAL); 704 \times 480 (NTSC) | | |
| | HDMI output | 1-ch, resolution: 1920 \times 1080P /60Hz, 1920 \times 1080P /50Hz, 1600 \times 1200 /60Hz, 1280 \times 1024 /60Hz, 1280 \times 720 /60Hz, 1024 \times 768 /60Hz | | |
| | VGA output | 1-ch, resolution: 1920 \times 1080P /60Hz, 1600 \times 1200 /60Hz, 1280 \times 1024 /60Hz, 1280 \times 720 /60Hz, 1024 \times 768 /60Hz | | |
| | Audio output | 2-ch, BNC (Linear, 600 Ω) | | |
| | Playback resolution | 5MP /3MP /1080P /UXGA /720P /VGA /4CIF /DCIF /2CIF /CIF /QCIF | | |
| Synchronous playback | 8-ch | 16-ch | 16-ch | |
| Hard disk | SATA | 4 SATA interfaces for 2 HDDs + 1 DVD-R/W (default), or 4HDDs | | |
| | eSATA | 1 eSATA interface | | |
| | Capacity | Up to 4TB capacity for each HDD | | |
| External interface | Network interface | 1 RJ-45 10 /100 /1000 Mbps self-adaptive Ethernet interface | | |
| | | 8 independent 100 Mbps PoE network interfaces | 16 independent 100 Mbps PoE network interfaces | |
| | Serial interface | RS-232; RS-485; Keyboard | | |
| | USB interface | 3 \times USB 2.0 | | |
| | Alarm in | 16 | | |
| | Alarm out | 4 | | |
| Others | Power supply | 100 ~ 240 VAC, 6.3 A, 50 ~ 60 Hz | | |
| | Consumption | \leq 45 W (without hard disk or DVD-R/W) | | |
| | Working temperature | -10 $^{\circ}$ C ~ +55 $^{\circ}$ C | | |
| | Working humidity | 10 % ~ 90 % | | |
| | Chassis | 19-inch rack-mounted 2U chassis | | |
| | Dimensions (W \times D \times H) | 445 \times 390 \times 90 mm | | |
| | Weight | \leq 4 Kg (8.8 lb) (without hard disk or DVD-R/W) | | |

HDD Storage Calculation Chart

The following chart shows an estimation of storage space used based on recording at one channel for an hour at a fixed bit rate.

| Bit Rate | Storage Used |
|----------|--------------|
| 96K | 42M |
| 128K | 56M |
| 160K | 70M |
| 192K | 84M |
| 224K | 98M |
| 256K | 112M |
| 320K | 140M |
| 384K | 168M |
| 448K | 196M |
| 512K | 225M |
| 640K | 281M |
| 768K | 337M |
| 896K | 393M |
| 1024K | 450M |
| 1280K | 562M |
| 1536K | 675M |
| 1792K | 787M |
| 2048K | 900M |
| 4096K | 1800M |
| 8192K | 3600M |
| 16384K | 7200M |



Please note that supplied values for storage space used is just for reference. The storage values in the chart are estimated by formulas and may have some deviation from actual value.

Accessing by Web Browser

Logging In

You can get access to the device via web browser. Open web browser, input the IP address of the device and then press Enter. The login interface appears.



Input the user name and password, and click the **Login** button.



- The default IP address is 192.0.0.64.
- The default user name is admin, and password is 12345.
- You may use one of the following listed web browsers: Internet Explorer 6.0, Internet Explorer 7.0, Internet Explorer 8.0, Internet Explorer 9.0, Internet Explorer 10.0, Apple Safari, Mozilla Firefox, and Google Chrome.
- The supported resolutions include 1024*768 and above.

When you log in for the first time, the system will remind you to install the Plug-in control. After the installation, you can configure and manage the device remotely.

Live View

The live view interface appears by default when you log in the device.



Interface Introduction

| No. | Name | Description |
|-----|--------------|---|
| 1 | Channel List | Displays the list of channels and the playing and recording status of each channel. |











| No. | Name | Description |
|-----|--------------------------------|---|
| 2 | Live View Window | Displays the image of channel, and multi-window division is supported. |
| 3 | Play Control Bar | Play control operations are supported. |
| 4 | PTZ Control | Pan, tilt, zoom operations are supported, as well as preset editing and calling.  PTZ function can only be realized if the connected camera supports PTZ control. |
| 5 | Video Parameters Configuration | Brightness, contrast, saturation and hue of the image can be edited. |

Start Live View

Steps:

1. In the live view window, select a playing window by clicking the mouse.
2. Double click a camera from the device list to start the live view.
3. You can click the  button on the toolbar to start the live view of all cameras on the device list.

Refer to the following table for the description of buttons on the live view window:

| Icon | Description | Icon | Description |
|---|--|---|-----------------------------|
|  | Select the window-division mode |  | Open/Close audio |
|  | Start/Stop all live view |  | Start/Stop two-way Audio |
|  | Capture pictures in the live view mode |  | Adjust volume |
|  | Start/Stop all recording |  | Enable/Disable digital zoom |
|  | Previous/Next page |  | Full screen |

Recording

Before you start

Make sure the device is connected with HDD or network disk, and the HDD or network disk has been initialized for the first time to use.

Two recording types can be configured: Manual and Scheduled. The following section introduces the configuration of scheduled recording.

Steps:

1. Click **Remote Configuration> Camera Settings> Record Schedule** to enter Record Schedule settings interface.
2. Select the camera to configure the record schedule.
3. Check the checkbox of **Enable Schedule** to enable recording schedule.

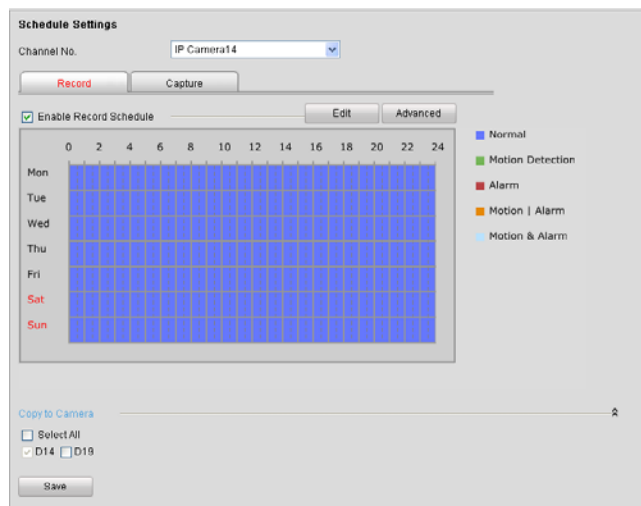

4. Choose the day in a week to configure scheduled recording.
5. Click **Edit** to edit record schedule.

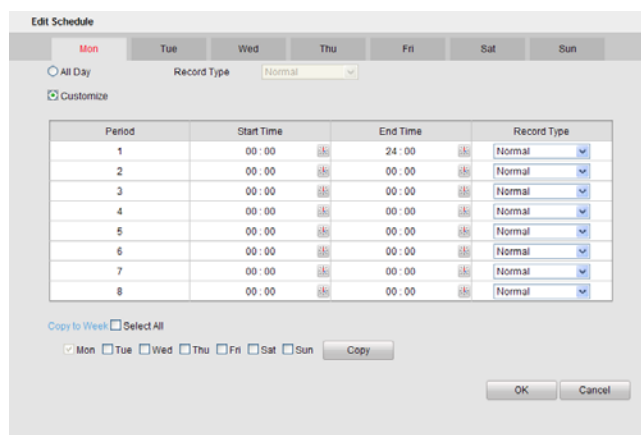

- 1) Configure All Day or Customize Record:
 - If you want to configure the all-day recording, please check the **All Day** checkbox.
 - If you want to record in different time sections, check the **Customize** checkbox. Set the **Start Time** and **End Time**.



Up to 8 segments can be configured and each segment cannot be overlapped.

- 2) Select a **Record Type**. The record type can be Normal, Motion, Alarm, Motion & Alarm, and Motion | Alarm.
- 3) Check the checkbox of **Select All** and click **Copy** to copy settings of this day to the whole week. You can also check any of the checkboxes before the date and click **Copy**.
- 4) Click **OK** to save the settings and exit the **Edit Schedule** interface.
6. Click **Advanced** to configure advanced record parameters.
7. Click **Save** to validate the above settings.

Playback



Interface Introduction

| No. | Name | Description |
|-----|------------------|--|
| 1 | Channel List | Displays the list of channels and the playing status of each channel. |
| 2 | Playback Window | Displays the image of channel. |
| 3 | Play Control Bar | Play control operations are supported. |
| 4 | Time Line | Displays the time bar and the records marked with different colors. |
| 5 | Playback Status | Displays the playback status, including channel number and playback speed. |
| 6 | Calendar | You can select the date to play. |

Start Playback

Steps:

1. Click **Playback** on the menu bar to enter playback interface.
2. Click the camera from the device list for playback.
3. Select the date from the calendar and click **Search**.
4. Click the **Play** button to play the video file searched on the current date.
5. Use the buttons on the toolbar to operate in playback mode.

| Button | Description | Button | Description |
|--------|----------------------|--------|------------------|
| | Play/Pause | | Stop |
| | Slow down | | Speed up |
| | Play by single frame | | Capture |
| | Stop all playback | | Download |
| | Video clip | | Open/Close audio |
| | Full screen | | |

6. You can drag the progress bar with the mouse to locate the exact playback point. You can also input the time

in the textbox : : and click button to locate the playback point.

The color of the video on the progress bar stands for the different video types.



Log

You can view and export the log files at any time, including operation, alarm, exception and information of device.

Before you start:

The Log function can be realized only when the device is connected with HDD or network disk.

Steps:

1. Click **Log** on the menu bar to enter the Log interface.

| No. | Time | Major Type | Minor Type | Channel No. | Local/Remote User | Remote Host IP |
|-----|---------------------|------------|------------------------------|-------------|-------------------|----------------|
| 1 | 2013-02-28 09:38:38 | Operation | Remote: Get Parameters | | admin | 192.168.1.12 |
| 2 | 2013-02-28 09:38:38 | Operation | Remote: Get Parameters | | admin | 192.168.1.12 |
| 3 | 2013-02-28 09:38:38 | Operation | Remote: Get Parameters | | admin | 192.168.1.12 |
| 4 | 2013-02-28 09:38:38 | Operation | Remote: Get Parameters | | admin | 192.168.1.12 |
| 5 | 2013-02-28 09:38:38 | Operation | Remote: Get Parameters | | admin | 192.168.1.12 |
| 6 | 2013-02-28 09:38:38 | Operation | Remote: Get Parameters | | admin | 192.168.1.12 |
| 7 | 2013-02-28 09:38:38 | Operation | Remote: Get Parameters | | admin | 192.168.1.12 |
| 8 | 2013-02-28 09:38:38 | Operation | Remote: Get Parameters | | admin | 192.168.1.12 |
| 9 | 2013-02-28 09:38:38 | Operation | Remote: Get Parameters | | admin | 192.168.1.12 |
| 10 | 2013-02-28 09:38:38 | Operation | Remote: Get Parameters | | admin | 192.168.1.12 |
| 11 | 2013-02-28 09:38:38 | Operation | Remote: Configure Parameters | A4 | admin | 192.168.1.12 |
| 12 | 2013-02-28 09:38:38 | Operation | Remote: Configure Parameters | A4 | admin | 192.168.1.12 |
| 13 | 2013-02-28 09:38:38 | Operation | Remote: Configure Parameters | A4 | admin | 192.168.1.12 |
| 14 | 2013-02-28 09:38:38 | Operation | Remote: Get Parameters | | admin | 192.168.1.12 |
| 15 | 2013-02-28 09:38:38 | Operation | Remote: Get Parameters | | admin | 192.168.1.12 |
| 16 | 2013-02-28 09:38:38 | Operation | Remote: Get Parameters | | admin | 192.168.1.12 |
| 17 | 2013-02-28 09:38:39 | Operation | Remote: Get Parameters | | admin | 192.168.1.12 |
| 18 | 2013-02-28 09:38:40 | Operation | Remote: Get Parameters | | admin | 192.168.1.12 |
| 19 | 2013-02-28 09:38:41 | Operation | Remote: Get Parameters | | admin | 192.168.1.12 |
| 20 | 2013-02-28 09:38:41 | Operation | Remote: Get Parameters | | admin | 192.168.1.12 |
| 21 | 2013-02-28 09:38:41 | Operation | Remote: Get Parameters | | admin | 192.168.1.12 |
| 22 | 2013-02-28 09:38:42 | Operation | Remote: Configure Parameters | A3 | admin | 192.168.1.12 |
| 23 | 2013-02-28 09:38:42 | Operation | Remote: Configure Parameters | A3 | admin | 192.168.1.12 |
| 24 | 2013-02-28 09:38:42 | Operation | Remote: Configure Parameters | A3 | admin | 192.168.1.12 |
| 25 | 2013-02-28 09:38:42 | Operation | Remote: Get Parameters | | admin | 192.168.1.12 |
| 26 | 2013-02-28 09:38:42 | Operation | Remote: Get Parameters | | admin | 192.168.1.12 |
| 27 | 2013-02-28 09:38:42 | Operation | Remote: Get Parameters | | admin | 192.168.1.12 |
| 28 | 2013-02-28 09:38:42 | Operation | Remote: Get Parameters | | admin | 192.168.1.12 |
| 29 | 2013-02-28 09:38:47 | Operation | Remote: Get Parameters | | admin | 192.168.1.12 |
| 30 | 2013-02-28 09:38:47 | Operation | Remote: Get Parameters | | admin | 192.168.1.12 |

2. Set the log search conditions to refine your search, including the Major Type, Minor Type, Start Time and End Time.
3. Click the **Search** button to start searching log files.
4. The matched log files will be displayed on the list shown below.



Up to 2000 log files can be found each time, and 100 log files can be displayed on each page.

You can click the **Save Log** button to save the searched log files to local directory.

Menu Operation

Menu Structure

The menu structure of the HNR50P6 Series NVR:

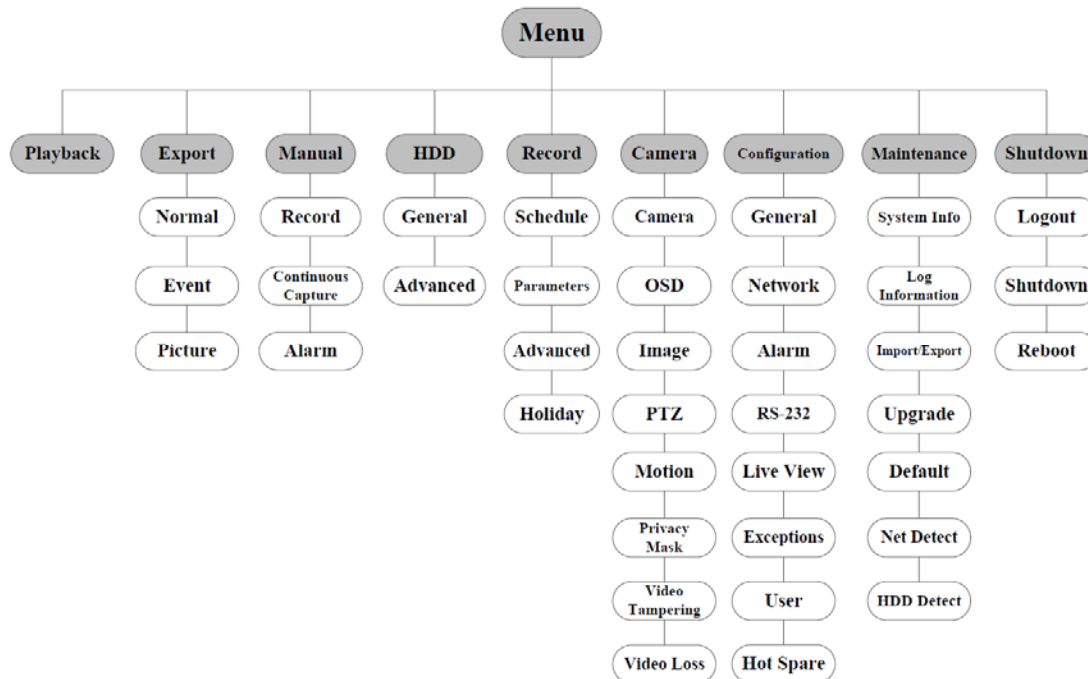

The menu structure of the HNRT00 Series NVR:

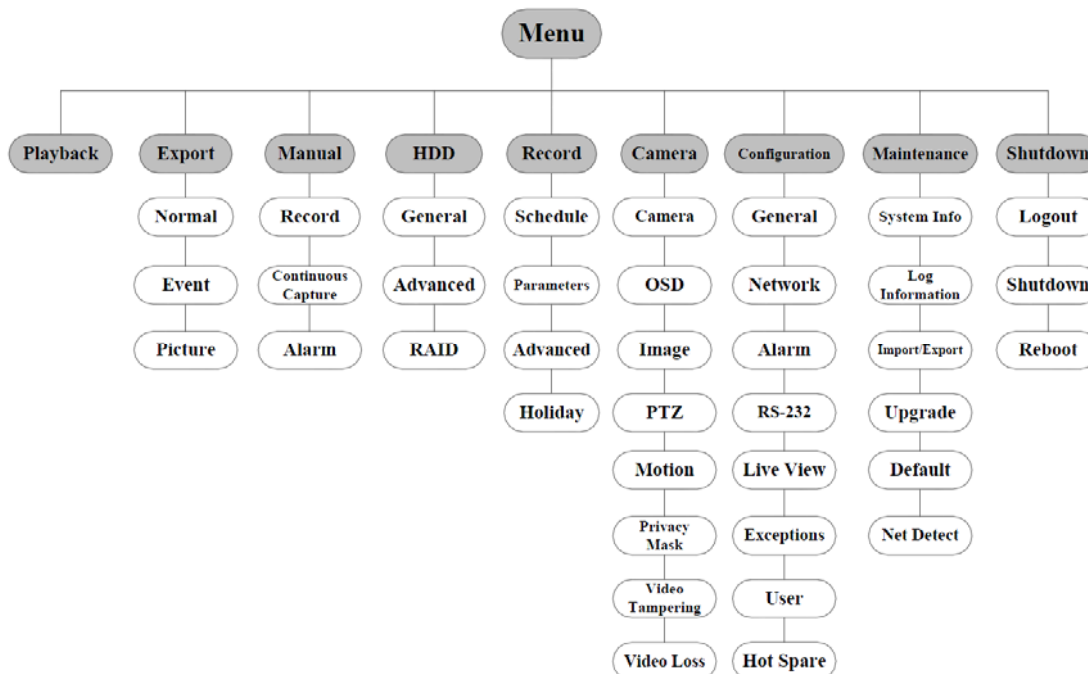

Startup and Shutdown

Proper startup and shutdown procedures are crucial to expanding the life of the NVR.

To start your NVR:

1. Check the power supply is plugged into an electrical outlet. It is HIGHLY recommended that an

Uninterruptible Power Supply (UPS) be used in conjunction with the device. The Power button (for the HNRT00 series on the front panel should be red, indicating the device gets the power supply.

2. Press the POWER button on the front panel. The Power LED should turn blue (for the HNRT00 series NVR) or green (for the HNR50P6 series NVR). The unit will begin to start.

After the device starting up, the wizard will guide you through the initial settings, including modifying password, date and time settings, network settings, HDD initializing, and recording.

To shut down the NVR:

1. Enter the Shutdown menu.

Menu > Shutdown

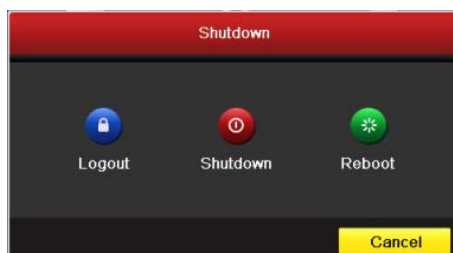

2. Select the **Shutdown** button.
3. Click the **Yes** button.

Live View

Some icons are provided on screen in Live View mode to indicate different camera status. These icons include:

Live View Icons

In the live view mode, there are icons at the upper-right corner of the screen for each channel, showing the status of the record and alarm in the channel, so that you can find problems as soon as possible.



Alarm (video loss, tampering, motion detection or sensor alarm)



Record (manual record, schedule record, motion detection or alarm triggered record)

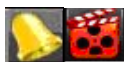

Alarm & Record



Event/Exception (event and exception information, appears at the lower-left corner of the screen.)

Adding IP Cameras

You should add and configure the online IP cameras to enable the live view and recording function.

Steps:

1. Right-click the mouse when you in the live view mode to show the right-click menu.

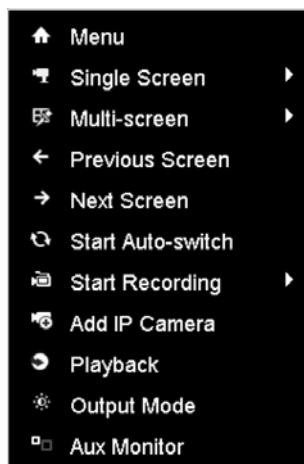

2. Select **Add IP Camera** in the pop-up menu to enter the IP Camera Management interface.

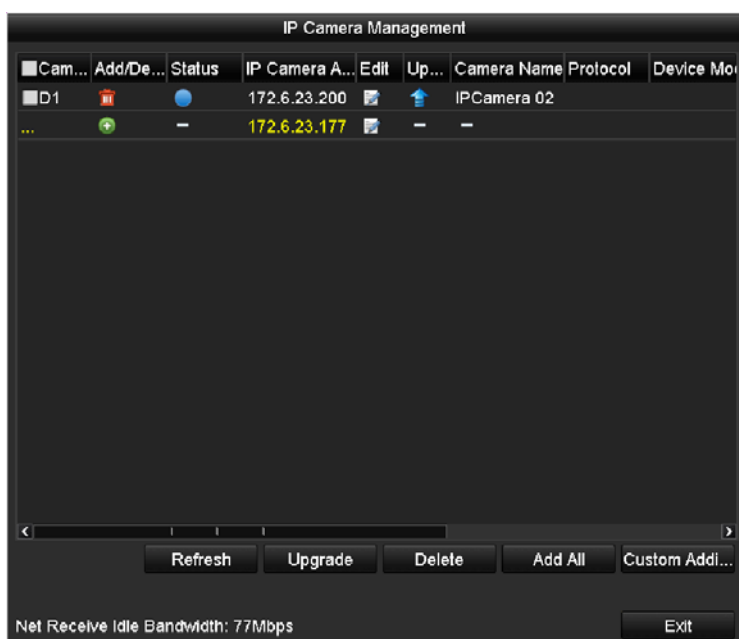







3. The online cameras with same network segment will be displayed in the camera list. Click the  button to add the camera.



The added camera is marked in white while the camera has not been added is marked in yellow.

Explanation of the icons

| Icon | Explanation | Icon | Explanation |
|---|-------------------------------------|---|--|
|  | Edit basic parameters of the camera |  | Add the detected IP camera. |
|  | The camera is connected. |  | The camera is disconnected; you can click the icon to get the exception information of camera. |
|  | Delete the IP camera |  | Advanced settings of the camera. |

4. To add other IP cameras:
 - 1) Click the **Custom Add** button to pop up the Add IP Camera (Custom) interface.

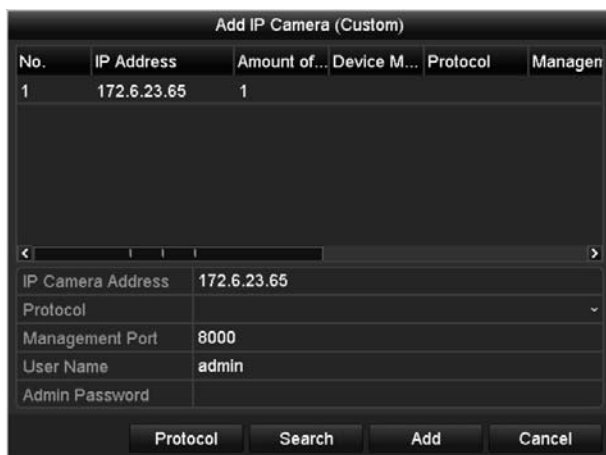

- 2) You can edit the IP address, protocol, management port, and other information of the IP camera to be added.
- 3) Click **Add** to add the camera.
- 4) (For the encoders with multiple channels only) check the checkbox of Channel No. in the pop-up window, as shown in the following figure, and click **OK** to finish adding.



One-touch RAID Configuration

Purpose:

For the HNRT00 series NVR, the disk array must be configured if you want to save recording and log files locally. Through one-touch configuration, you can quickly create the disk array. By default, the array type to be created is RAID 5.

Before you start:

As the default array type is RAID 5, at least 3 HDDs must be installed in you device.

Steps:

1. (For HNRT00 series only) Enable the RAID function by checking the checkbox in the disk mode configuration interface.
Menu > HDD > Advanced
2. Enter the Physical Disk Settings interface.
Menu > HDD > RAID

| No. | Capacity Array | Type | Status | Model | Hot Sp... |
|-----|----------------|--------|------------|-------------------|-----------|
| 1 | 931.51GB | Normal | Functional | ST31000340NS | |
| 3 | 931.51GB | Normal | Functional | ST31000526SV | |
| 5 | 931.51GB | Normal | Functional | WDC WD10EVVS-6... | |
| 7 | 931.51GB | Normal | Functional | WDC WD10EVVS-6... | |

3. Click **One-touch Configuration** button to enter the One-touch Array Configuration interface.

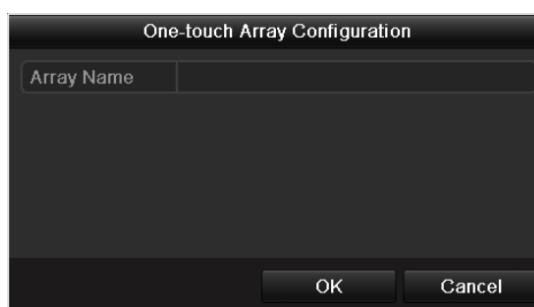

4. Edit the array name in the **Array Name** text field and click **OK** button to start configuring array.



If you install 4 HDDs or above for one-touch configuration, a hot spare disk will be set by default. It is recommended to set hot spare disk for automatically rebuilding the array when the array is abnormal.

5. When the array configuration is completed, click **OK** button in the pop-up message box to finish the settings.

Recording

Before you start:

Make sure that the HDD has already been installed. If not, please install a HDD and initialize it. You may refer to the user manual for detailed information.

Purpose:

Two kinds of record types are introduced in the following section, including Instant Record and All-day Record. And for other record types, you may refer to the user manual for detailed information.







After rebooting all the manual records enabled are canceled.

Instant Recording

On the live view window of each channel, there is a quick setting toolbar which shows on the bottom of the window when you click on it.



Click the  icon to enable the record, and the icon turns to . And click  icon to disable the record, then the icon turns to .

All-day Recording

Steps:

1. On the live view window, right click the window and move the cursor to the **Start Recording** option, and select **Continuous Record** or **Motion Detection Record** on your demand.
2. And click the **Yes** button in the popup Attention message box to confirm the settings. Then all the channels will start to record in the selected mode.

Playback

Play back the record files of a specific channel in the live view menu. Channel switch is supported.

● Option 1:

Choose a channel under live view using the mouse and click the  button in the shortcut operation menu.



Only record files recorded during the past five minutes on this channel will be played back.



● Option 2

Steps:

1. Enter the Playback menu.
Mouse: right click a channel in live view mode and select Playback from the menu.

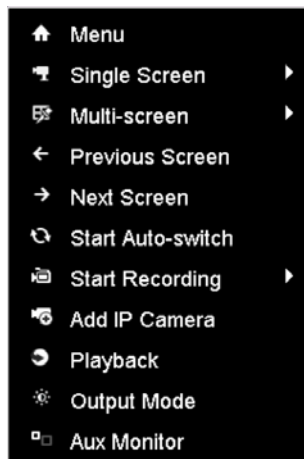

Front Panel: press PLAY button to play back record files of the channel under single-screen live view. Under multi-screen live view, record files of the selected channel will be played back.



Pressing numerical buttons will switch playback to related channels during playback process.

2. Playback management.

The toolbar in the bottom part of Playback interface can be used to control playing process.



Just check the channel or channels if you want to switch playback to another channel or execute simultaneous playback of multiple channels.

Backup

Recorded files can be backed up to various devices, such as USB flash drives, USB HDDs or a DVD writer.

Steps:

1. Enter Video Export interface.

Choose the channel(s) you want to back up and click the **Quick Export** button.



2. Enter Export interface, choose backup device and click **Export** button to start exporting.



3. Check backup result.

Choose the record file in Export interface and click button  to check it.

